

# Keysight MWC19 Press Event

*Andrea Dodini*

25.2.2019

*Marketing Manager, EMEA*



# Welcome!

<b>Brief Introduction</b>	Andrea Dodini <i>Marketing Manager EMEA</i>
<b>Keysight Solutions Accelerating 5G</b>	Satish Dhanasekaran <i>President, Communications Solutions Group</i>
<b>New VXG Microwave Signal Generators</b>	Mike Griffin <i>Marketing Manager, Wireless Communications</i>
<b>KeysightCare</b>	John Page <i>President, Keysight Global Services Org.</i>
<b>Q&amp;A</b>	
<b>Demo Tour</b>	

# Accelerating The Future Of 5G, Automotive, & IoT



## Chipset and Device Solutions

- C-V2X Connected Car
- Complete 5G OTA Test System
- 5G Device Workflow
- 5G Channel Emulator



## Infrastructure Test Solutions

- Streamline 5G Manufacturing
- 5G RAN Field Measurements
- Advancing 5G O-RAN
- Accelerate gNB Characterization



## Operator Solutions

- UE Emulation for gNB Validation
- Architect For Network Security
- Benchmark 5G Networks
- Deliver Better Cellular IoT



## Lifecycle Management

- KeysightCare: Support. Elevated.



# Keysight Solutions Accelerating 5G

# 5G Will Change The World

**\$3.5**  
trillion

5G mobile value chain by 2035

**25%**  
of all  
traffic

carried by 5G networks by 2024

**4.1**  
billion

cellular IOT connections by 2024

**22**  
million

jobs supported by 5G by 2035

**40%**  
global  
population

covered by 5G

# The 5G Race Is On...

## AROUND THE WORLD

- **Deployments are accelerating**  
More mobile operators launching 5G networks to capture new business models
- **Standards are maturing**  
New use cases driving new standards evolution
- **Technical complexity is high**  
Diversity driven by multiple regional ecosystems progressing in parallel

# 5G Trends Driving Industry Evolution

Deployments  
are  
accelerating

## Rollout Announcements

2019: 20  
2020: 37

## Investments

192 operators  
in 81 countries

## Ecosystems

>18 device makers using  
Qualcomm's 5G modem

Standards  
are  
maturing

## Acceleration

5G NR NSA freeze  
pulled in 6 mos. to Dec '17

## Maturation

R15 5G NR Jun '18 freeze  
& Mar '19 late drop freeze

## Extension

R16/17/18 5G NR extensions  
for V2X, URLLC & beyond

Technical  
complexity  
is high

## Global Diversity

5G NR NSA vs. SA  
progressing in parallel

## More Bands and BW

New bands: 32 FR1 & 4 FR2,  
with more BW options

## Spatial Challenges

Beamforming, tracking,  
and link management



# Accelerating 5G Commercialization



# Keysight's Total Solutions Drive Industry Acceleration

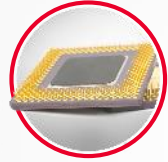

**COMPONENTS & CHIPSETS**



**DEVICES**



**BASE STATIONS**



**HYPERSCALE AND DATA CENTERS**



**ENTERPRISE**

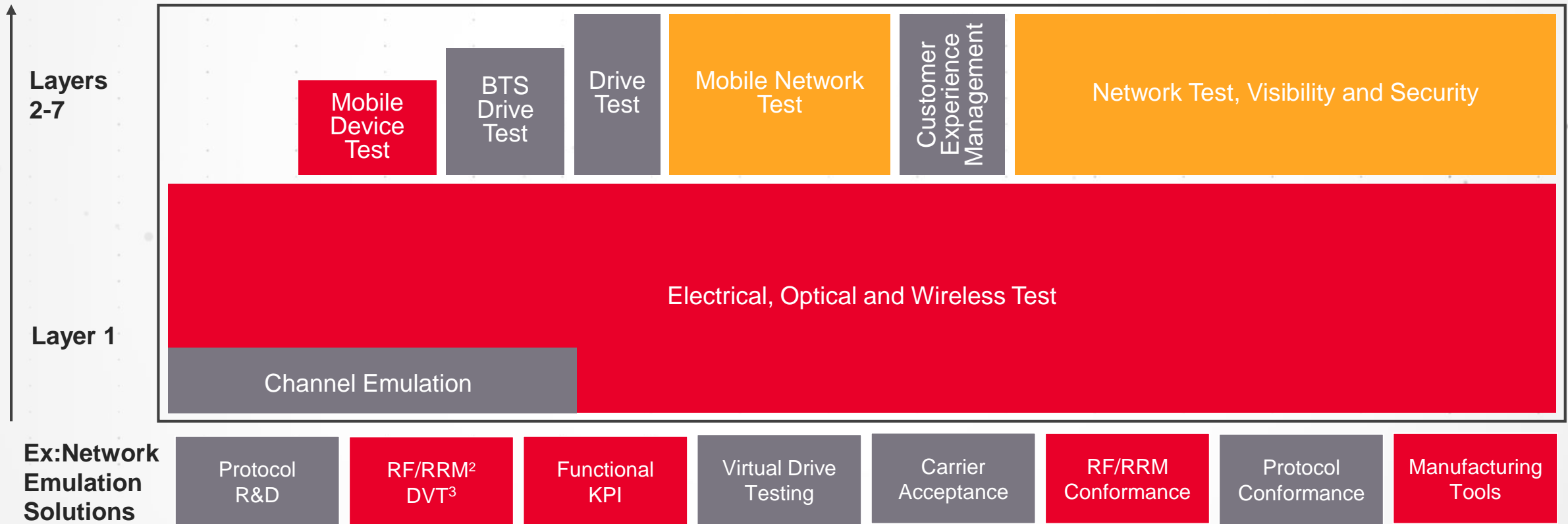

■ Keysight Classic   ■ Ixia   ■ Anite

# Keeping Pace With 5G NR Standards

ENABLING FIRST-TO-MARKET SOLUTIONS THAT ACCELERATE INDUSTRY READINESS

- Keysight contributes more to the development of **5G NR** than any other test vendor:
  - Authored more than **300 RAN4/5 5G NR** contributions
  - **Leading in GCF/PTCRB** test case validation for 5G NR RF SA and NSA device certification
  - **Simplified OTA testing** with compact antenna test range (CATR) method adopted by 3GPP
- **Stay ahead** of the standards using Keysight's:
  - 5G Conformance Toolset
  - 5G mmWave Testbed
  - 5G NR Software Solutions



*"Keysight's 5G test solutions are instrumental in accelerating commercial 5G development and rollout."*

Tony Schwarz, Senior VP of Engineering, Qualcomm Technologies

# Enabling Market Leaders

## FierceWireless

WIRELESS TECH 5G IOT

Wireless

### Keysight going strong

by [Monica Allevan](#) | Aug 23, 2018 7:35am

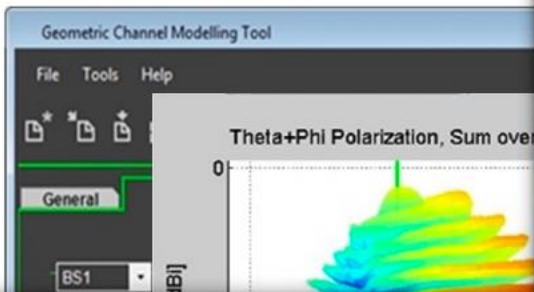

## telecoms.com



### Keysight claims first 5G device testing toolset



HOME ABOUT US PROJECTS SERVICES NEWS CAREERS CONTRACTORS

### OUR NEWS

HOME NEWS KEYSIGHT TECHNOLOG...

Keysight Technologies inks 5G deal with China Telecom

### The U.S. firm also secured a 5G collaboration agreement with Korean carrier SK Telecom



## RCR Wireless News

INTELLIGENCE ON ALL THINGS WIRELESS

### Keysight Technologies inks 5G deal with China Telecom



SD-WAN 2 5G 9 Edge 10 IoT 4 SDN 7 NFV 7 Containers Security 8 AI 9 Data Center 4 Storage 4 APM/NPM 2 Op

### Keysight Provides NTT DoCoMo With 5G Network Emulation for 5G NR Devices



Ali Longwell  
August 21, 2018  
11:45 am MT

ASPENCORE NETWORK ABOUT US SUBSCRIBE

## EE Times

HOME NEWS PERSPECTIVES DESIGNLINES VIDEOS RADIO EDUCATION IOT TIMES

DESIGNLINES | TEST & MEASUREMENT DESIGNLINE

### Qualcomm, Keysight Achieve 2-Gbps Wireless Downloads

# 5G Public Collaborations Around The World

## ACCELERATING 5G COMMERCIALIZATION

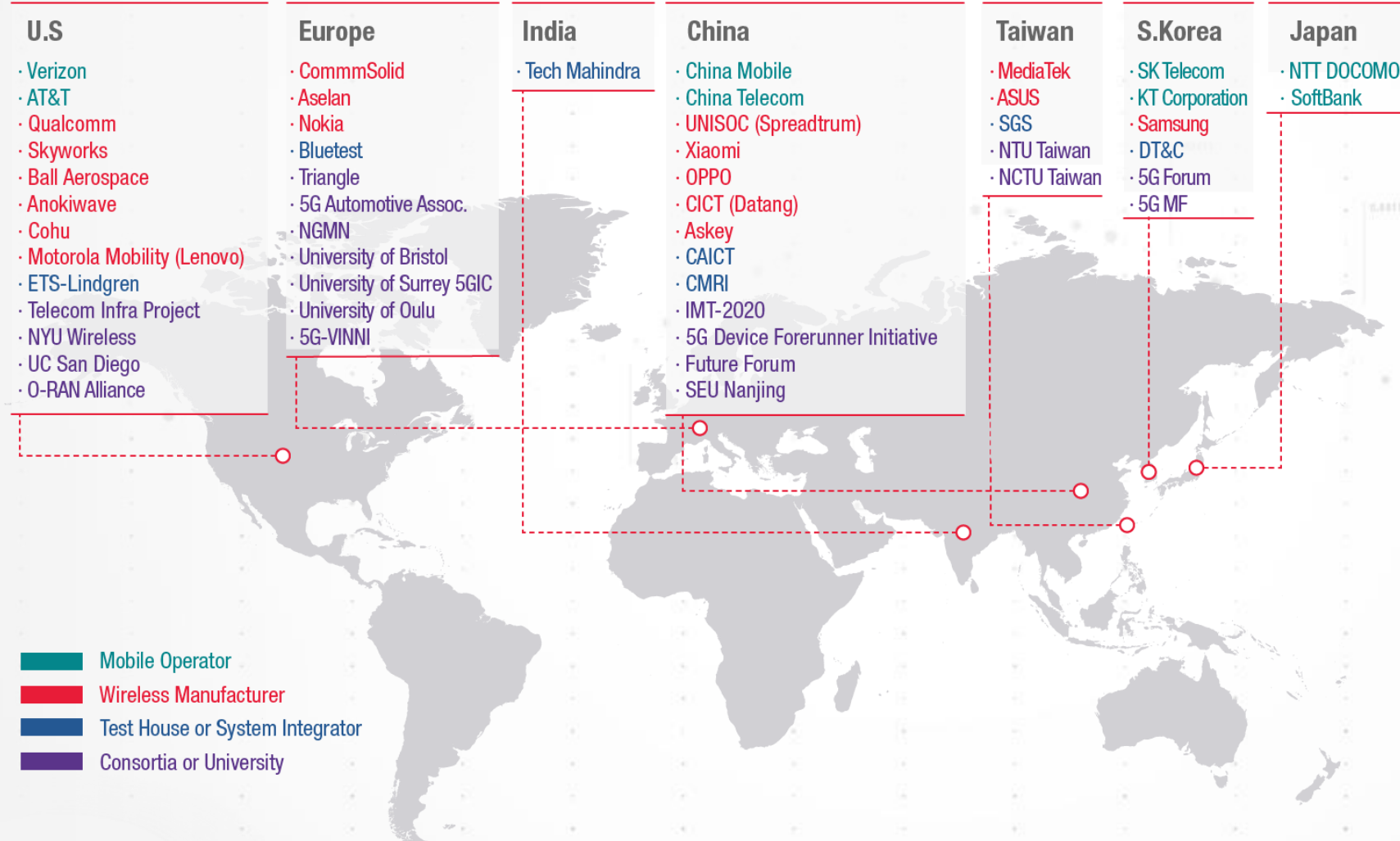

- Engaged early with 5G industry leaders across the connected ecosystem
- Delivered end-to-end 5G solutions to accelerate workflow

# Accelerating 5G Deployments

## INDUSTRY-FIRST SOLUTIONS

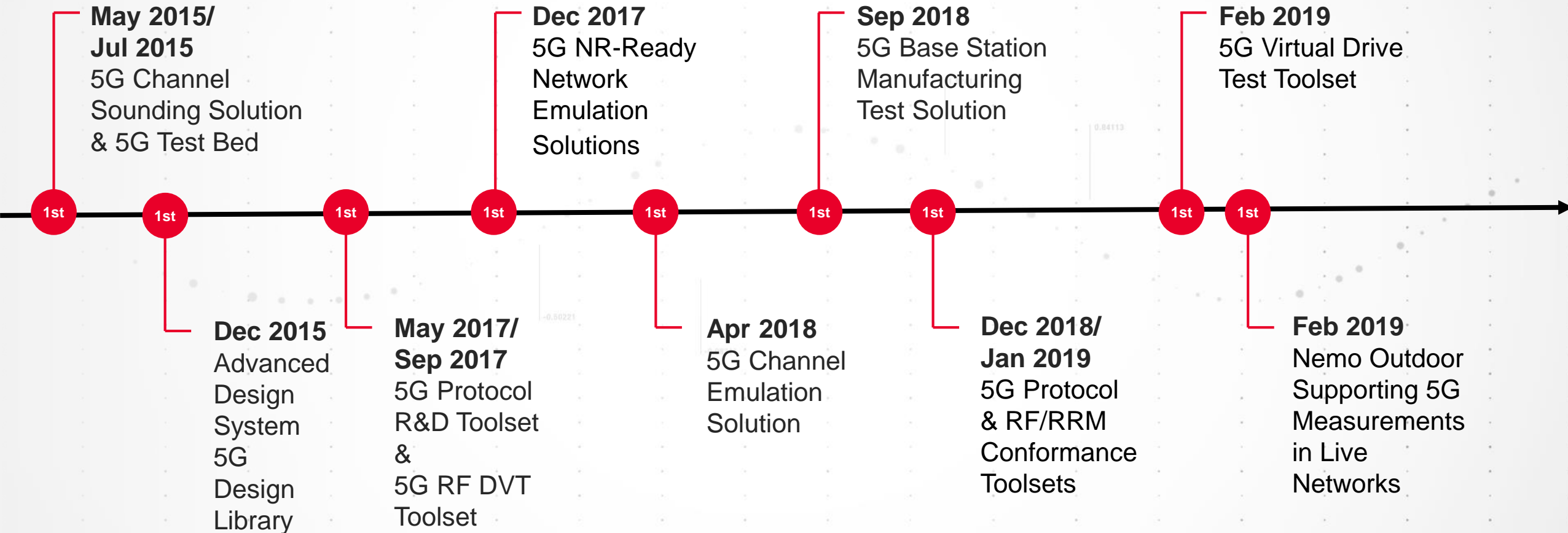

# 5G Solutions To Connect The Workflow

## STREAMLINING TIME-TO-MARKET

Design  
& Validation

Conformance  
& Acceptance

Manufacturing

Deployment  
& Operations

- Advanced Design Simulation
- mmWave Test Bed
- Network & UE Emulation

- Protocol Conformance
- RF/RRM Conformance
- Carrier Acceptance

- RFFE / RFIC Mfg.
- Base Station Mfg.
- Device Mfg.

- Field Test
- Drive Test
- Monitoring & Security

PATHWAVE

Connects the Workflow: Open, Scalable, Predictive

# Keysight Solutions Showcase Leading 5G Technology

>15 DEMOS ACROSS THE MOBILE ECOSYSTEM

- Accelerating first wave of 5G smartphones
  - China Mobile
  - Motorola Mobility (Lenovo)
  - Xiaomi
  - MediaTek
  - AAC Technologies
- Powering Automotive and VR applications
  - HTC
  - Qualcomm Technologies
- 5G RAN and 5G Core
  - ASTRI
  - Corning
  - Xilinx
  - Movandi
  - Siverts IMA
  - Ocastic

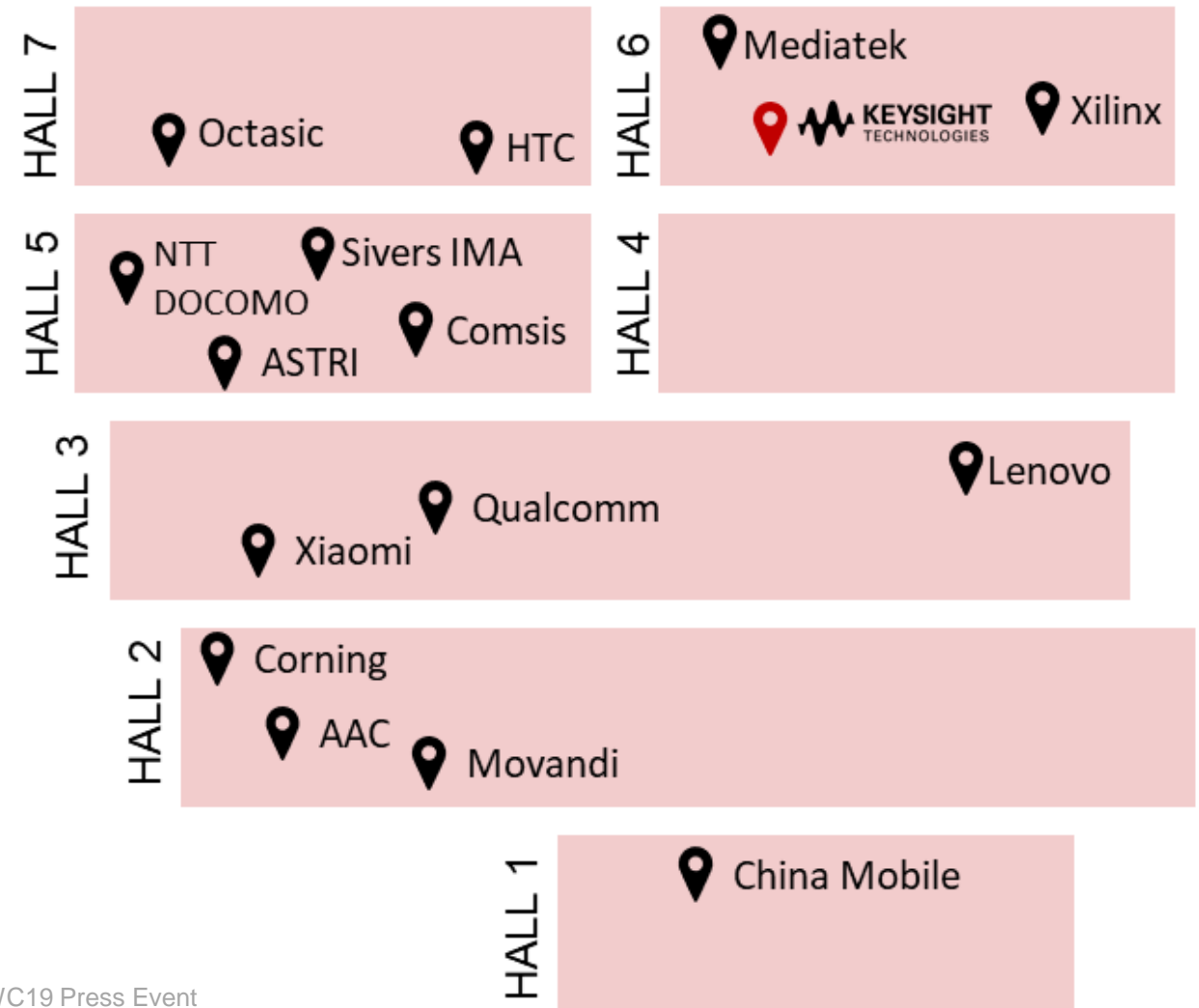

# Accelerating O-RAN Development

## FLEXIBILITY FOR SERVICE PROVIDERS

- Addressing new vertical market revenue opportunities
- Leading standards development to create a robust interoperability framework
- End-to-end visibility, validation, and performance test capability
- Two O-RAN demos:
  - Industry first white box demonstration of an O-RAN 5G radio unit (RU) with Xilinx, AT&T, Ball Aerospace and Anokiwave
  - PoC O-RAN fronthaul test solution demonstration for validating MTI 5G RUs at NTT DOCOMO's booth

Operator Defined Next Generation  
RAN Architecture and Interfaces



Leading the industry towards open,  
interoperable interfaces and RAN virtualization





# Mastering The Complexities Of 5G Technology

# Technology Shifts In Wireless Communications

ADDRESSING GROWING WIRELESS DATA DEMANDS



Denser Modulation Schemes



Beamforming

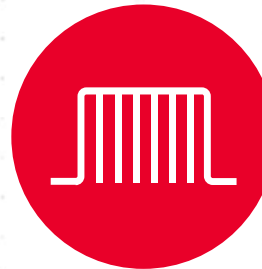

Wider Bandwidths



mmWave Frequency Bands



MIMO

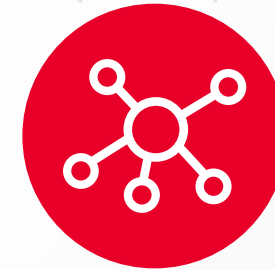

New OPEN Interfaces in RAN



# Introducing Keysight VXG Microwave Signal Generators

ADVANCED SIGNAL GENERATION FOR MILLIMETER WAVE APPLICATIONS

# High-Performance

## TEST SOLUTIONS

- Scalable and flexible 5G signal generation and analysis tools
- Integrated Over-the-Air testing using versatile chamber solutions
- **New:** VXG microwave signal generator



# Introducing the VXG Microwave Signal Generators

LEADING THE WAY IN MILLIMETER WAVE TEST

VXG  
M9384B



Multi-touch Benchtop

VXG-m  
M9383B



Modular

R&D

DVT

MFG

PATHWAVE Connecting the Workflow



Superior modulation quality



Up to 2 GHz bandwidth



Dual channels



44 GHz



Phase coherent channels

# Industry-Leading Performance

## INTEGRATED MULTI-CHANNEL HARDWARE

- World's first dual-channel 1 MHz - 44 GHz Vector Signal Generator w/2 GHz modulation bandwidth
- World's lowest phase noise microwave Vector Signal Generator for OFDM
- World's highest output power ideal for 5G PA or OTA testing with ultra-low ACP and EVM
- Dual phase-coherent channels



AVAILABLE VERSIONS: MULTI-TOUCH BENCHTOP OR MODULAR

# mmWave Test Challenges

## 5G DESIGN AND VALIDATION



Complex test system setup and calibration routine for 5G NR signal generation



Measurement integrity and uncertainty for radiated tests



Short product development cycle and time to market

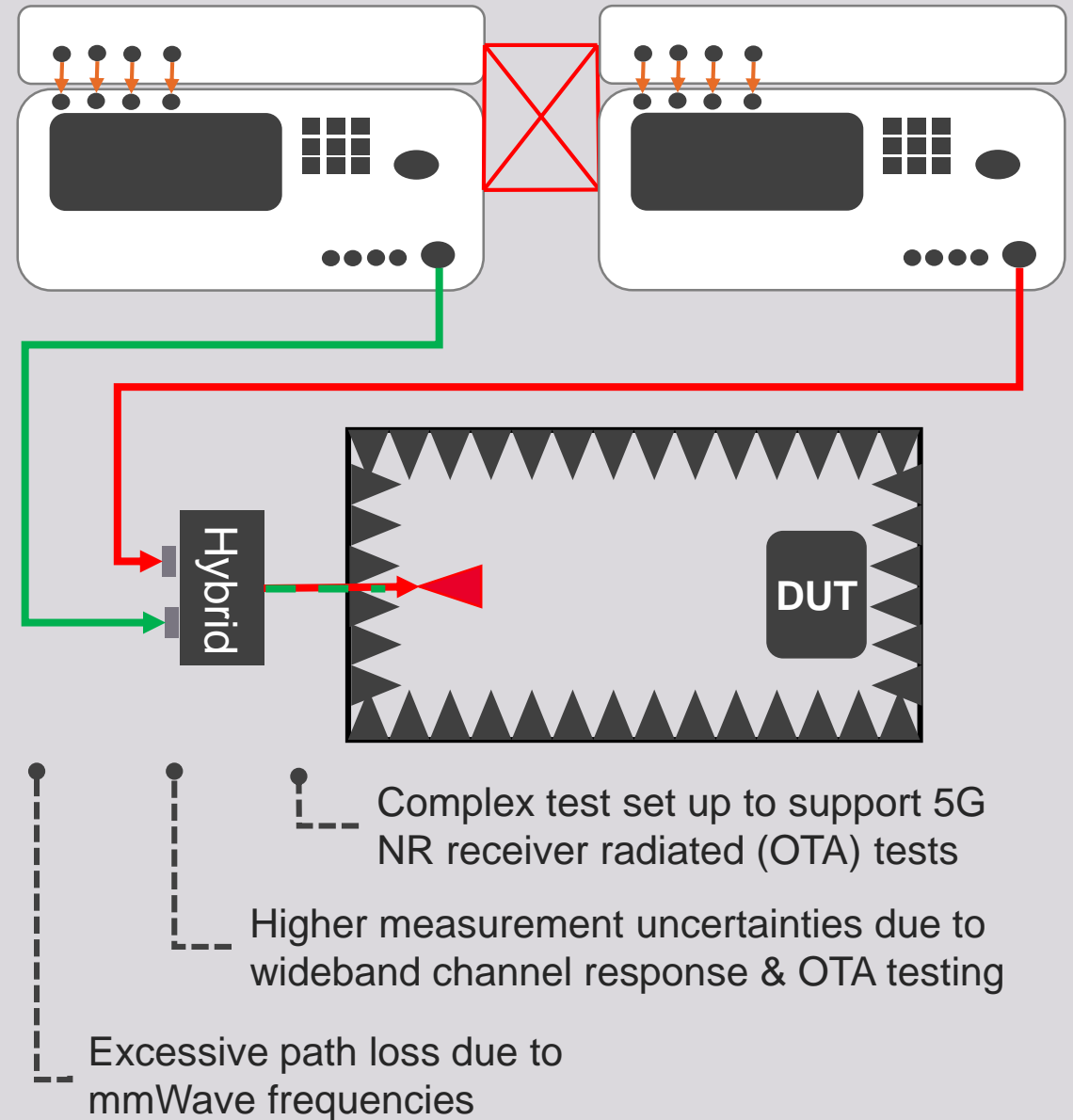

# VXG/VXG-m

## KEY BENEFITS



Simplify measurement setup and calibration routine



Optimize measurement integrity and minimize measurement uncertainty



Accelerate product development cycle and time to market







# KeysightCare

SUPPORT. ELEVATED.

# KeysightCare – Support. Elevated.

KEEPING PROJECTS ON SCHEDULE & MINIMIZING UNPLANNED DOWNTIME

## Assured

Fast, committed support



## Enhanced

Priority support



## Performance

Proactive, enterprise support



# Services Accelerating 5G Innovation

TIME TO MARKET FOR 5G DEPLOYMENTS AND COMPLEX TECHNOLOGIES



## Business challenges

- Network speed and signal integrity with wide BW mmWave transmission
- Staff expertise
- Do more with less



## KeysightCare

Minimize unplanned downtime and training cost through on-demand test expertise

Avoid project delays, achieve faster TTM through proactive notification of enhancements



Decrease expense: **Test Asset Optimization Services**

Master the complexities of 5G: **Education Services**

Affordable access to latest 5G test solutions:  
**Technology Refresh**

# Services for Automotive Electronics

ACCELERATE 5G INTEGRATION AND ENSURE PRODUCT SAFETY



## Business challenges

- Integration of CV2X, 5G, Infotainment, EV and autonomous vehicle technologies.
- Compliance to industry and OEM standards
- Internal test capacity constraints



## KeysightCare

Timely access to 5G, WiFi, CV2X and EV application experts.

Minimize unplanned downtime



Reduce testing and repair costs:  
**One stop and System Calibration**

Manage test system costs for emerging technologies: **Technology Refresh & Financial Services**



# Keysight Solutions In Summary

# Accelerating 5G Innovation

## ACROSS THE WIRELESS ECOSYSTEM

- Collaborating with market leaders to enable industry-first technology launches
- Setting the standard in 5G NR and establishing a first-to-market track record
- Mastering the complexities of 5G technologies with high-performance test & measurement solutions
- Delivering end-to-end solutions to streamline workflow spanning from Layer 1-7
- KeysightCare Services to avoid project delays, minimize downtime, and accelerate time to market



# Accelerating the Future of 5G, Automotive, and IoT Today



## Chipset and Device Solutions

- C-V2X Connected Car
- Complete 5G OTA Test System
- 5G Device Workflow
- 5G Channel Emulator



## Infrastructure Test Solutions

- Streamline 5G Manufacturing
- 5G RAN Field Measurements
- Advancing 5G O-RAN
- Accelerate gNB Characterization



## Operator Solutions

- UE Emulation for gNB Validation
- Architect For Network Security
- Benchmark 5G Networks
- Deliver Better Cellular IoT



## Lifecycle Management

- KeysightCare: Support. Elevated.

# BACKUP



# For More Information

## KEYSIGHTCARE SERVICES

- KeysightCare
  - Web: [www.keysight.com/us/en/products/services/keysightcare-service-and-support.html](http://www.keysight.com/us/en/products/services/keysightcare-service-and-support.html)
  - Press release and backgrounder: <https://about.keysight.com/en/newsroom/pr/>
  - Stop by our booth Monday through Thursday for a live demo in booth 6G30-20.
- Keysight Services
  - Test Asset Optimization: [www.keysight.com/us/en/products/services/test-asset-management-and-optimization.html](http://www.keysight.com/us/en/products/services/test-asset-management-and-optimization.html)
  - Technology Refresh: [www.keysight.com/en/pc-2557359/technology-refresh-services](http://www.keysight.com/en/pc-2557359/technology-refresh-services)